

Carter® Ground Fueling
Pressure Refueling Nozzle

Model 64348



Powering Business Worldwide

Design Concepts

Eaton's Carter Model 64348 underwing fueling nozzle has been used world-wide in the aircraft fueling industry for many years. It includes a true swivel disconnect and compact flow control handle, allowing easy connection to the aircraft.

Features

- Easier swiveling under all conditions. Swivel independent of quick disconnect (QD)
- Connects to 3-lug international standard aircraft adapter
- Designed in accordance with new SAE design specification for commercial nozzles AS5877
- Self-adjusting pressure-loaded nose seal. No mechanical adjustments or springs used. Leak free under extreme side loads, worn adapters and extreme temperatures.
- Optional easy change nose seal — no tools required
- Lead-in ramps (interface with aircraft adapter lugs) of stainless steel for longer life
- Positive mechanical interlock — nozzle can not be opened until connected to aircraft and can not be removed from aircraft in the open position

- Flow control handle of high strength zinc-aluminum alloy
- Replaceable bicycle handles and grips standard for ease of operation. Circular grip optional.
- Two threaded ports in nozzle body for simultaneous vacuum breaker and product sampling fitting installation are standard
- Lightweight and rugged
- Modular construction with use of bolt flanges minimized
- 2, 2-½, & 3 inch NPT & BSPP threaded QD inlets available
- Optional 40, 60 and 100-mesh screens retained with snap rings for ease of removal
- 35 psi (2.413 bar), 45 psi (3.103 bar) & 55 psi (3.792) hose end control valves (HECV) available
- Dry break or ball valve for easy strainer inspection available
- Low pressure drop
- Optional bonding cable and vacuum breaker
- Redundant safety lock on QD

Envelope Dimensions

Dimensions shown in inches (millimeters)

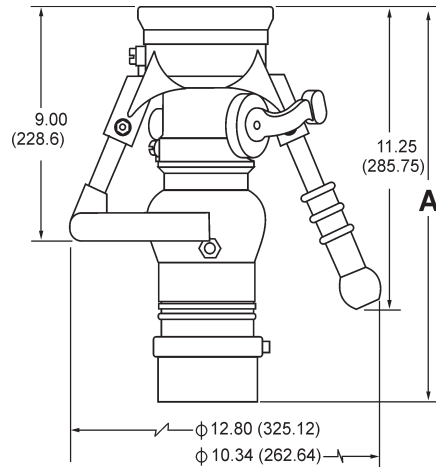

Options	Dimension "A"	
	in	(mm)
3H, K-N, P	14.51	(368.55)
6H, K-N, P	9.46	(240.28)
7H, K-N, P	11.72	(297.69)
9H, K-N, P	9.59	(243.59)
J	8.20	(208.28)
F*3H, K-N, P	18.06	(468.50)
F*26H, K-N, P, F*6H, K-N, P	14.65	(372.11)
F*17H, K-N, P, F*7H, K-N, P	16.41	(416.81)
F**F*3H, K-N, P	2.71	(68.83)
F**F*26H, K-N, P, F*6H, K-N, P	19.84	(503.94)
F**F*29K, N, P, F**F*9K, N, P	19.9	(505.46)
F**F29L, M, F**F9L, M	20.49	(520.45)

* 3, 4 or 5 HECV

Technical Data

Hose End Control Valves

The hose end control valve (HECV) is designed to limit pressure at its outlet (at the pressure sensing port in the nozzle). The control pressure is a function of the main spring that loads the poppet. In addition, surge and lockup (no flow pressure) are controlled. Refer to Model 60129-1 brochure (TF100-76) for more details on how this is accomplished.

The following characteristics are typical:

- Normal spring setting (maximum pressure limits will be 5 psi (0.345 bar) greater than spring). Spring settings of 35 psi (2.413 bar), 45 psi (3.103 bar) & 55 psi (3.792 bar) available.
- Surge pressure control — 65 psi (5.171 bar) maximum for 55 psi (3.792 bar) HECV. 55 psi (3.792 bar) maximum for 35 psi (2.413 bar) and 45 psi (3.103 bar) HECVs. All HECV spring settings have 0.5 second valve closure (minimum).
- Lock up pressure — 10 psi (0.689 bar) maximum over spring setting for 45 psi (3.103 bar) & 55 psi (3.792 bar) units. Maximum of 20 psi (1.379 bar) over spring setting for 35 psi (2.413 bar) unit.
- Pressure limitation — 5 psi (0.345 bar) over spring setting with inlet pressure up to 100 psi (6.895 bar)
- Hysteresis (difference in pressure limits between increasing and decreasing flow rates) — pressure limits with decreasing flow rates will normally be slightly greater than for increasing flow rates
- Defueling is possible through unit; however, a blockout device is required to maintain maximum flow. Use Carter brand Model 61656 blockout device.
- Model 61656 blockout device is recommended if system secondary control valve is to be checked

HECV Pressure Drop Curves

The curves described below are typical for the inlet pressures and flow rates shown in a system with appropriate back pressure. These curves are applicable to all Eaton Carter brand HECV models.

- Curve 1** Control pressure with 100 psi (6.895 bar) inlet pressure
- Curve 2** Control pressure with 90 psi (6.205 bar) inlet pressure
- Curve 3** Control pressure with 75 psi (5.171 bar) inlet pressure

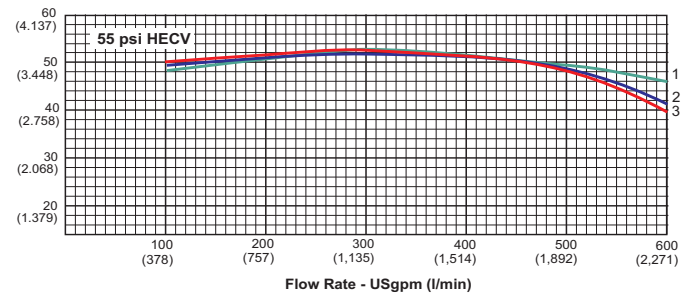
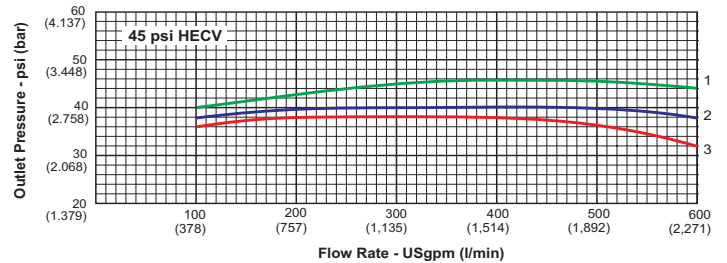
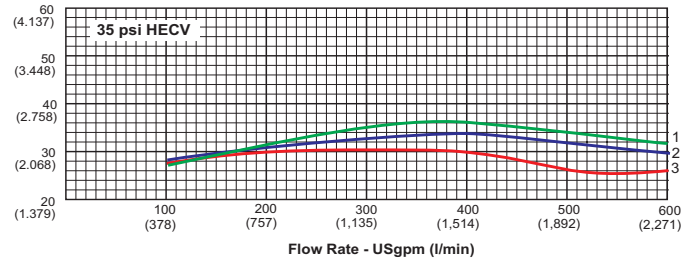

Flow Characteristics

Model 64348 flow rates, including aircraft adapter use

- Curve 1** 64348C6H nozzle with 100-mesh screen and 2-½ inch inlet
- Curve 2** 643486H nozzle without screen and with 2-½ inch inlet
- Curve 3** 64348CF46H nozzle with 100-mesh screen, 45 psi (3.103 bar) HECV and 2-½ inch inlet

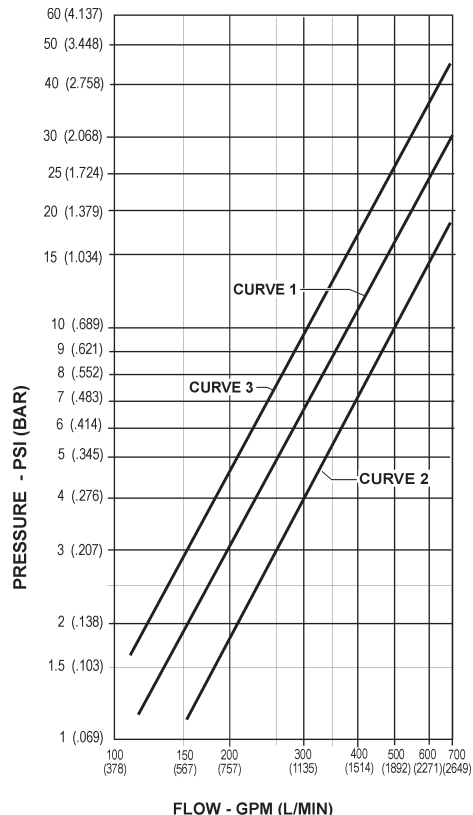

Ordering Data

The part number for a complete nozzle consists of four parts as illustrated (right) and described below.

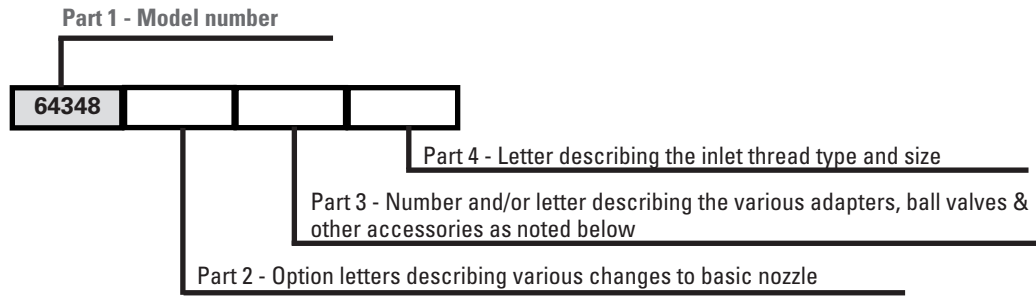

Part 2

The following options may be added as part 2 of the part number as indicated above to order a unit to meet your requirement.

Option	Description	Option	Description
*A	Adds 40-mesh screen	G	Replaces standard handles with long handles
*B	Adds 60-mesh screen	H	Adds drag ring to nozzle with any option F in conjunction with option T or options 1 or 6 from part 3
*C	Adds 100-mesh screen	J	Adds adapter to allow mating to 60427 QD
D	Adds bonding cable	Q	Adds fuel sample QD (GTP-235-3/8)
E	Adds vacuum breaker	***R	Adds flight refueling adapter
**F3	Adds 35 psi (2.413 bar) HECV	T	Adds adapter to mate with Whittaker accessories
**F4	Adds 45 psi (3.103 bar) HECV	U	Replaces standard handle with circular handle
**F5	Adds 55 psi (3.792 bar) HECV		
*	Options A, B & C only available when a male half from part 3 or option R is specified		
**	To obtain a nozzle with a dual HECV setup, specify two options in series, e.g. F5F4 results in 55 psi (3.792 bar) and 45 psi (3.103 bar) units with the former assembled nearest the nozzle inlet. If two HECVs are desired specify the highest pressure setting first.		
***	Option R only available with 47013 HECV		

Part 3

The configuration of the inlet is defined by adding the appropriate number or number and option letter from the table (right) in conjunction with the appropriate option letter from part 4 below. The nozzle may terminate in an adapter half only, if desired. In this case, leave part 4 blank. To obtain a female half, QD or dry break, or to complete the specification of the ball valve outlet, part 4 must be completed.

Option	Description	Option	Description
*1	For nozzle with flanged inlet HECV	R	Adds defuel key with option 3 only
*2	For nozzle with swivel inlet HECV	4	Adds male adapter half (44697) to mate with basic nozzle and dry break QD (61154)
3	Adds ball valve (64015). Part 4 must be completed with option 3. Add options D, E, J and R for other accessories to complete the specification.	6	Adds male adapter half to mate standard QD
D	Adds glass inspection port to ball valve	7	Adds male adapter half to mate dry break QD when a single HECV is used
E	Adds drag ring to ball valve	9	Adds male adapter half (43046 with HECV, 44362 without HECV) to mate 60427 style QD
J	Adds operating handle with option 3 only		
*	If Option 1 or 2 is not used with any other option, then the shortest configuration nozzle will be provided		

Part 4

Options specifying the desired thread for adapters or ball valves selected in part 3.

Option	Description	Option	Description
H	Inlet thread — 2-1/2 inch NPT	*M	Inlet thread — 3 inch BSPP
K	Inlet thread — 2-1/2 inch BSPP	P	Inlet thread — 2 inch NPT
*L	Inlet thread — 3 inch NPT		
* 3 inch Inlet threads not available with option 3 ball valves			

Examples:

- 64348CD6H Nozzle with 100-mesh screen, bonding cable and standard QD with 2-1/2 inch NPT inlet thread
- 64348BF41 Nozzle with 60-mesh screen, 45 psi (3.103 bar) HECV with inlet flange to mate 60427 type accessories. Note — no inlet QD or other configuration is specified in this case.
- 64348F514P Nozzle with 55 psi (3.792 bar) HECV with flanged adapter half and 61154 dry break with 2 inch NPT inlet. Note — swivel adapter half can be specified by using 64348F524P.

Illustrated Options & Weights

* For a dual HECV setup specify two options in series; e.g. F5F4 results in 55 psi (3.792 bar) and 45 psi (3.103 bar) units with the former assembled nearest the nozzle inlet. If two HECVs are desired, specify the highest pressure setting first.

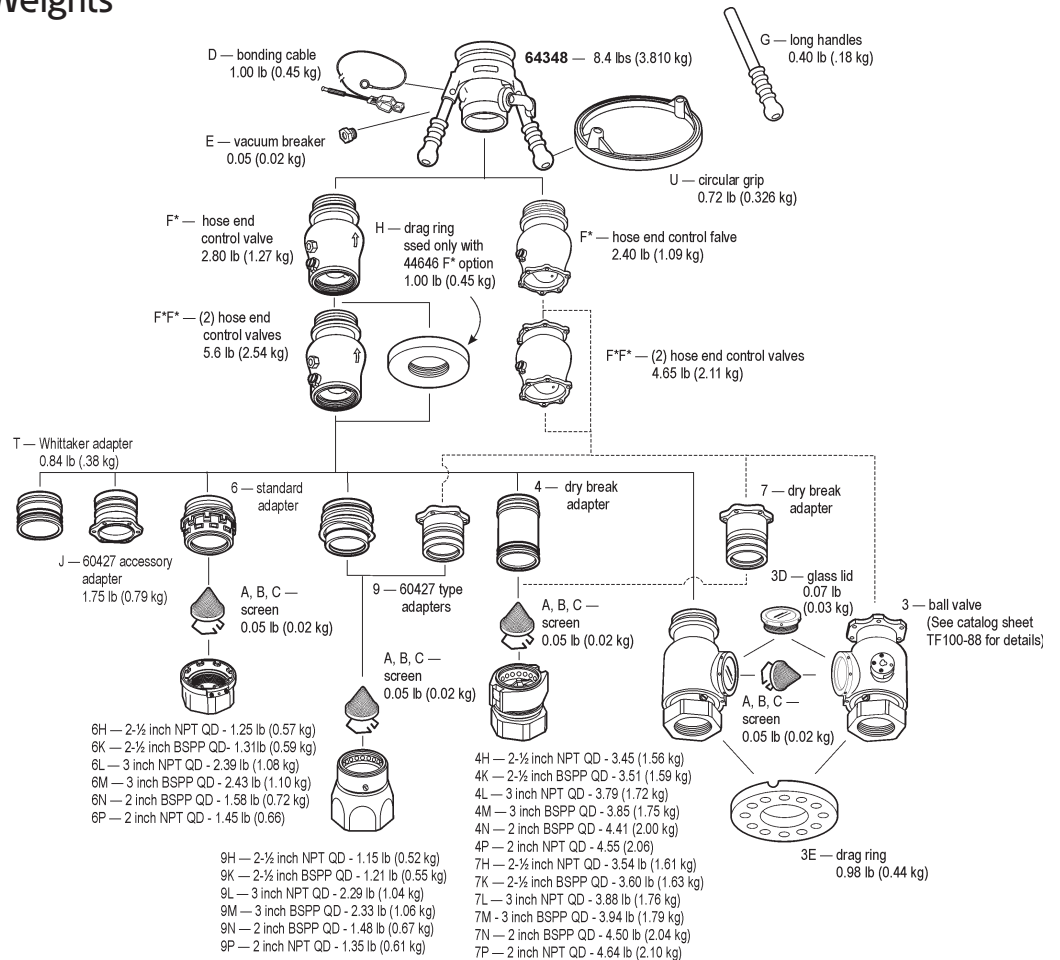

*F3 = 35 psi (2.413 bar) HECV
 F4 = 45 psi (3.103 bar) HECV
 F5 = 55 psi (3.792 bar) HECV

For a dual HECV setup specify two options in series, F5F4 results in 55 psi (3.792 bar) and 45 psi (3.193 bar) units with the former assembled nearest the nozzle inlet. If two HECV's are desired, specify the highest pressure setting first.

The following special tools are recommended for the maintenance of the Model 64348 nozzle:

61607 Ball Tool for Model 64348/64349/61428 & 61429 Nozzles

Model 61607 ball removal and installation tool is utilized to collect and automatically count the balls used in the swivel joints of the nozzle. It is simple to use and assures that the proper installation is achieved. It

is suggested that a separate tool be used for each swivel joint. A minimum of two are required for the simplest of nozzle configurations (one for the collar swivel and one for the hose swivel). Three are required for a nozzle having a hose end control valve (HECV) or a ball valve.

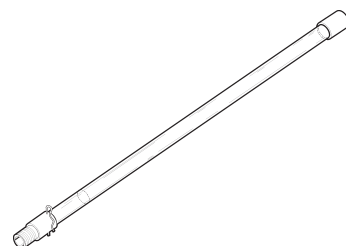

64000 Poppet Adjustment Gauge

This simple inexpensive gauge provides an accurate method of achieving the proper adjustment of the poppet of Model 64348 nozzle. The gauge can be used on all Carter brand underwing nozzles, except Models 64200 and 64250. Use gauge Model 64250ST-1 for these later nozzles.

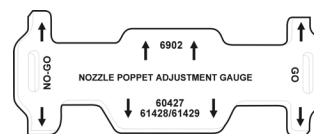

61656 Blockout Device

Model 61656 blockout device is recommended for use when defueling through a hose end control valve (HECV) or when it is necessary to check a secondary pressure control device in a system. Model 61656 does not introduce fuel into the ambient port of the HECV which can later become a dangerous spray during operation. It can be used on most Carter brand hose end control valves.

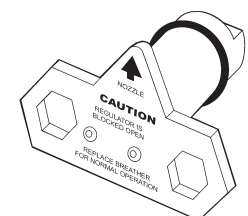

**Eaton
Aerospace Group
Conveyance Systems Division
9650 Jeronimo Road
Irvine, California 92618
Phone: (949) 452 9500
Fax: (949) 452 9992**

Eaton
Aerospace Group
Conveyance Systems Division
90 Clary Connector
Eastanollee, Georgia 30538
Phone: (706) 779 3351
Fax: (706) 779 2638

Eaton
Aerospace Group
Conveyance Systems Division
300 South East Avenue
Jackson, Michigan 49203-1972
Phone: (517) 787 8121
Fax: (517) 787 5758

Eaton
Aerospace Group
Conveyance Systems Division
11642 Old Baltimore Pike
Beltsville, Maryland 20705
Phone: (301) 937 4010
Fax: (301) 937 0134

Eaton
Aerospace Group
Conveyance Systems Division
15 Pioneer Ave.
Warwick, Rhode Island 02888
Phone: (401) 781 4700
Fax: (401) 785 4614

Eaton S. A.
Aerospace Group
Conveyance Systems Division
2 Rue Lavoisier BP 54 78310
Coignieres, France
Phone: (33) 130 69 30 00
Fax: (33) 130 69 30 56

Eaton Limited
Aerospace Group
Conveyance Systems Division
Broad Ground Road
Lakeside, Redditch
Worcestershire
B98 8YS
United Kingdom
Phone: (44) 1527 517555
Fax: (44) 1527 517556

Eaton S.A
Aerospace Group
Conveyance Systems Division
62 Chemin De Pau
64121 Serres-Castet
France
Phone: (33) 559 333 864
Fax: (33) 559 333 865

Eaton GmbH
Aerospace Group
Conveyance Systems Division
Rudolf-Diesel-Strasse 8
82205 Gilching
Germany
Phone: 49 (0) 8105 7530
Fax: 49 (0) 8105 7555

Vickers Systems Pte Ltd
Aerospace Group
Conveyance Systems Division
Lot 512, Jalan Delima,
Batamindo Industrial Park
Batam 294533, Indonesia
Phone: (62) 770 611823
Fax: (62) 770 611821

Eaton
Aerospace Group
9650 Jeronimo Road
Irvine, California 92618
Phone: (949) 452 9500
Fax: (949) 452 9555
www.eaton.com/aerospace

©2009 Eaton
All Rights Reserved
Printed In USA
Form No. TF100-106A
July 2009